



HI-LITE MFG. CO., INC.

13450 Monte Vista Avenue
 Chino, California 91710
 Telephone: (909) 465-1999
 Toll Free: (800) 465-0211
 Fax: (909) 465-0907
 www.hilitemfg.com

JOB NAME:		
SCALE: N.T.S.	DATE: S.M.	TYPE:
DRAWN BY:	QTY:	
SHEET:		REV:

HiLite Mfg
 Proprietary
 Drawing

HiLite Mfg
 Proprietary
 Drawing

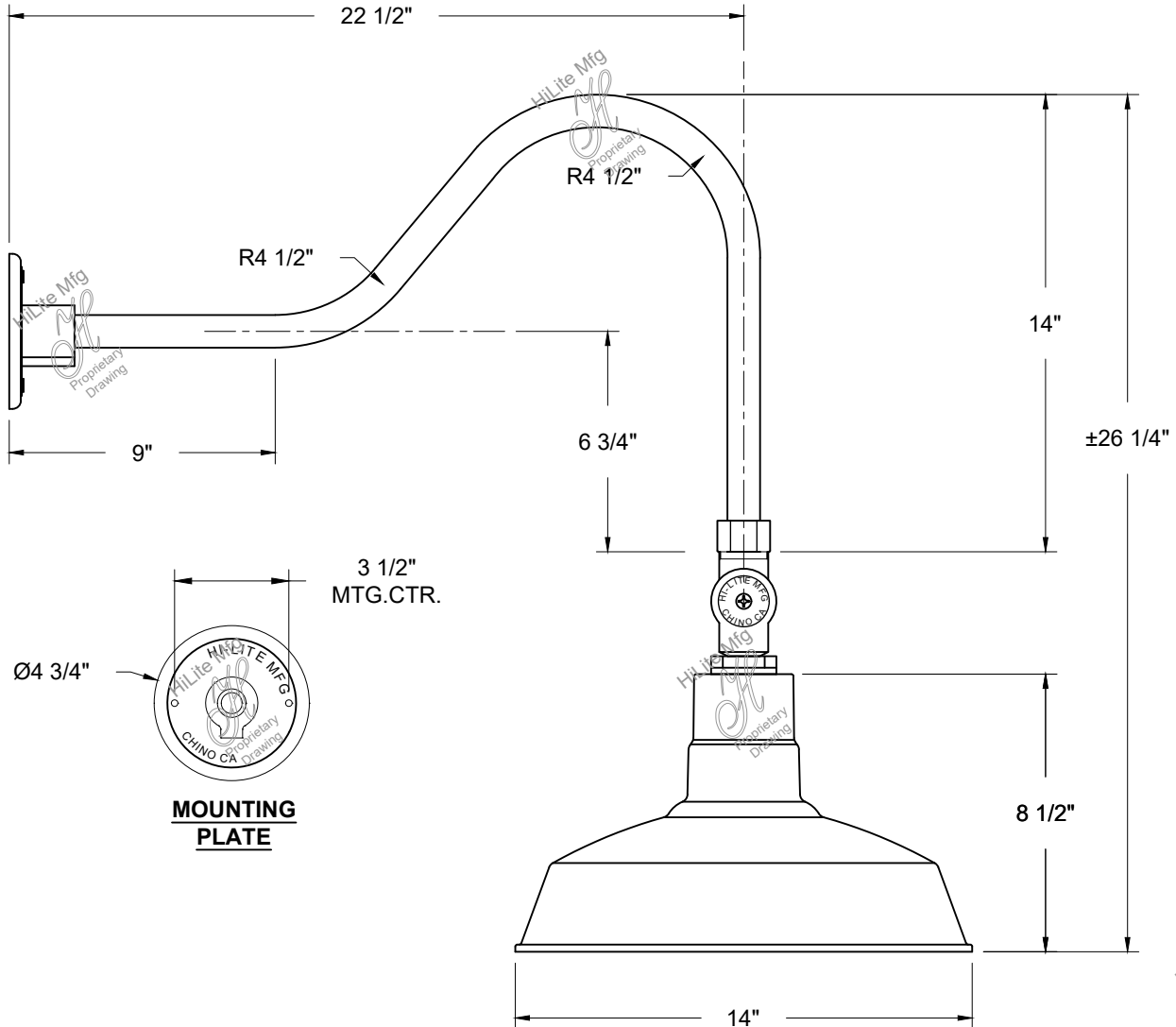

HiLite Mfg
 Proprietary
 Drawing

HiLite Mfg
 Proprietary
 Drawing



WET LOCATION

Item Number	Wattage	Voltage
H-QSN15114-SA/QSNHL-H/QSNSK	200W	120V

Finish
 91-Black, 93-White, 96-Galvanized,
 145-Oil Rubbed Bronze

Mounting
 Wall Mount

Lamp/Socket
 1-Medium Base INC

***Confidential and Proprietary. The information contained on this page is the sole property of Hi-Lite Mfg. Co., Inc. Any reproduction, redistribution, or use to profit from in part or as a whole without prior written authorization of Hi-Lite Mfg. Co., Inc. is unlawful, against trade laws and will be prosecuted to the fullest extent.